

Order Form TRACOE *mini* For Custom Made Tubes*

THIS IS A DIGITAL FILLABLE PDF

Personal Information

Customer			
Name and contact details			
Name of the patient	Protected by HIPAA	Patient ID	

Order

REF + Size	Number of units	Was ordered before	
		Yes <input type="checkbox"/>	Order number: _____ No <input type="checkbox"/>

Product Information

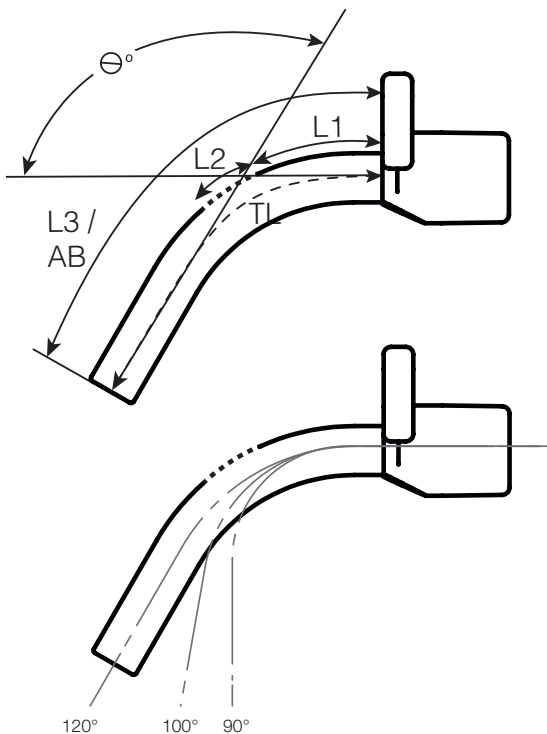

- L1: Distance between neck flange and the start of the fenestration
- L2: Length of fenestration. Distance between the top edge of the first hole and the bottom edge of the last hole of the fenestration
- L3 / AB: Length along outer bend (greatest length)
- TL: Length from the middle line of the neck flange until the end of the tube

Θ° Bending angle: The standard *mini* tube bending angle is about 120°.
You can also order a bending angle of 100° or 90°.





















Bending angle		
120°	100°	90°
<input type="checkbox"/>	<input type="checkbox"/>	<input type="checkbox"/>

No fenestration (as standard tube)

TL: _____

L3 / AB: _____

With fenestration (only possible for sizes 4.0 - 6.0)

Tube Size	Hole image of the fenestration: 1 - 4 possible				Number of fenestration: 1 - 4 possible	Diameter / Height fenestration (in mm)	Length fenestration L2 (in mm)	L1 (in mm)
						standard		
4.0					1 <input type="checkbox"/> 2 <input type="checkbox"/> 3 <input type="checkbox"/> 4 <input type="checkbox"/>	2.5	15	10
4.5					1 <input type="checkbox"/> 2 <input type="checkbox"/> 3 <input type="checkbox"/> 4 <input type="checkbox"/>	2.5	15	10
5.0					1 <input type="checkbox"/> 2 <input type="checkbox"/> 3 <input type="checkbox"/> 4 <input type="checkbox"/>	3.0	16	11
5.5					1 <input type="checkbox"/> 2 <input type="checkbox"/> 3 <input type="checkbox"/> 4 <input type="checkbox"/>	3.0	16	11
6.0					1 <input type="checkbox"/> 2 <input type="checkbox"/> 3 <input type="checkbox"/> 4 <input type="checkbox"/>	3.0	16	11
Other								

Ideas & Supplements

Appendix: _____



If you have any questions, please contact us by phone at +49 6136 9169-320

Please fill out the order form and send it to order@tracoe.com or via fax to +49 6136 9169-289

Date Signature and company stamp

* Further please note that the delivery time for the custom made tube is extended and the product is excluded from return.

